

# BeSafe®

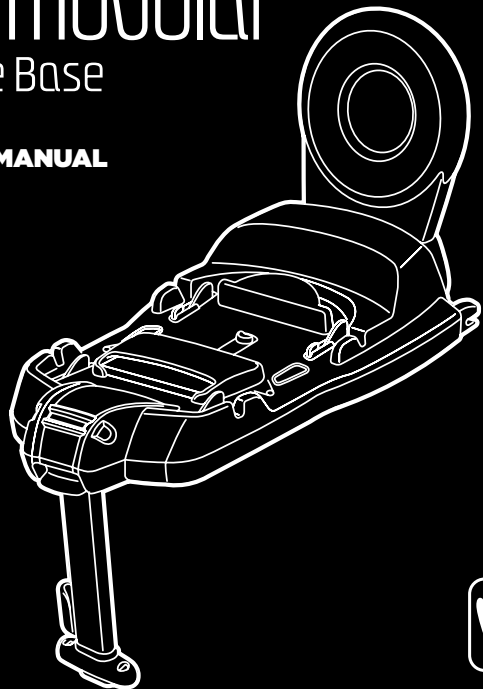





























## izi Modular™ i-Size Base

USER MANUAL



UN regulation no. R129  
i-Size

SCANDINAVIAN  
SAFETY

	8		72
	12		76
	16		80
	20		84
	24		88
	28		92
	32		96
	36		100
	40		104
	44		108
	48		112
	52		116
	56		120
	60		x
	64		x
	68		x

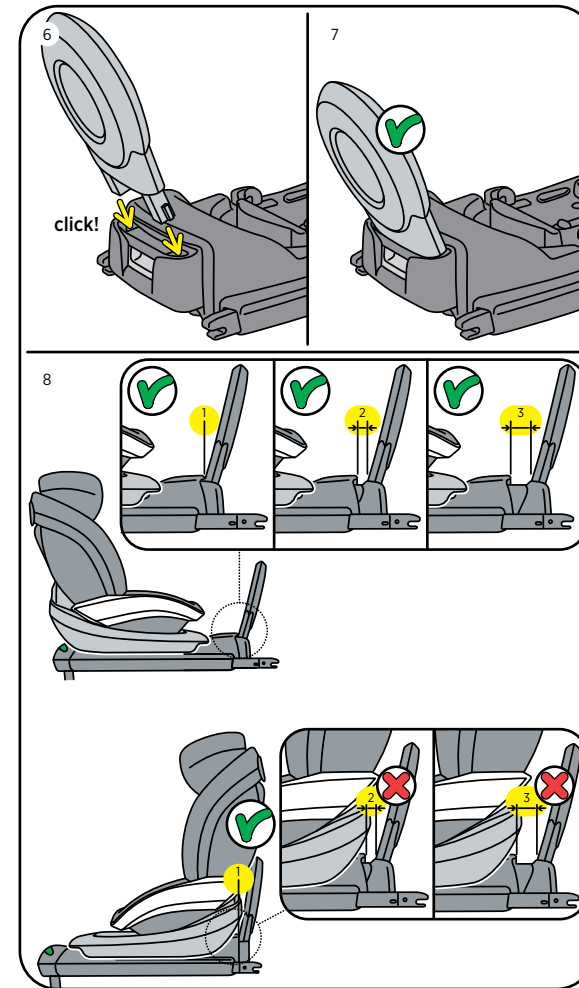
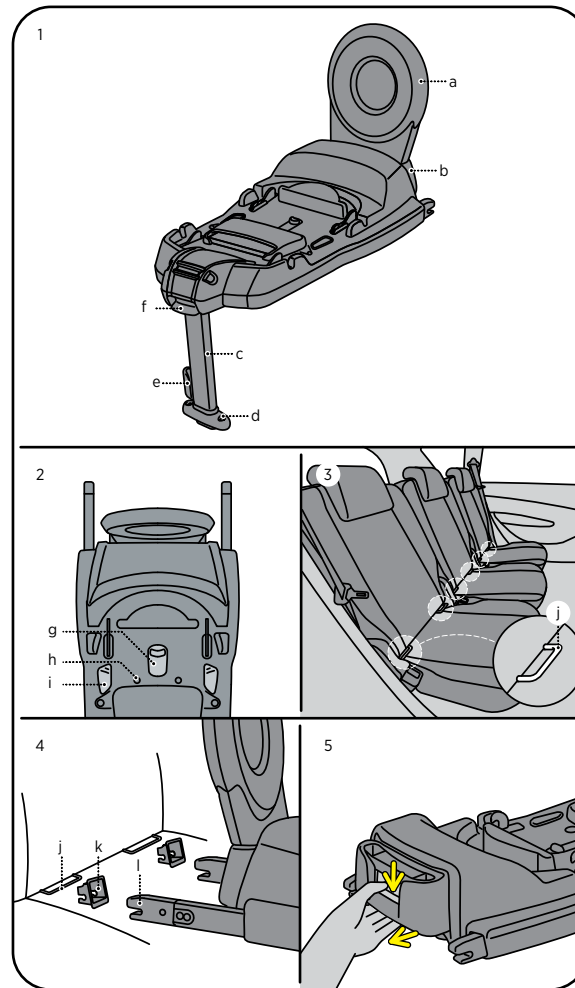

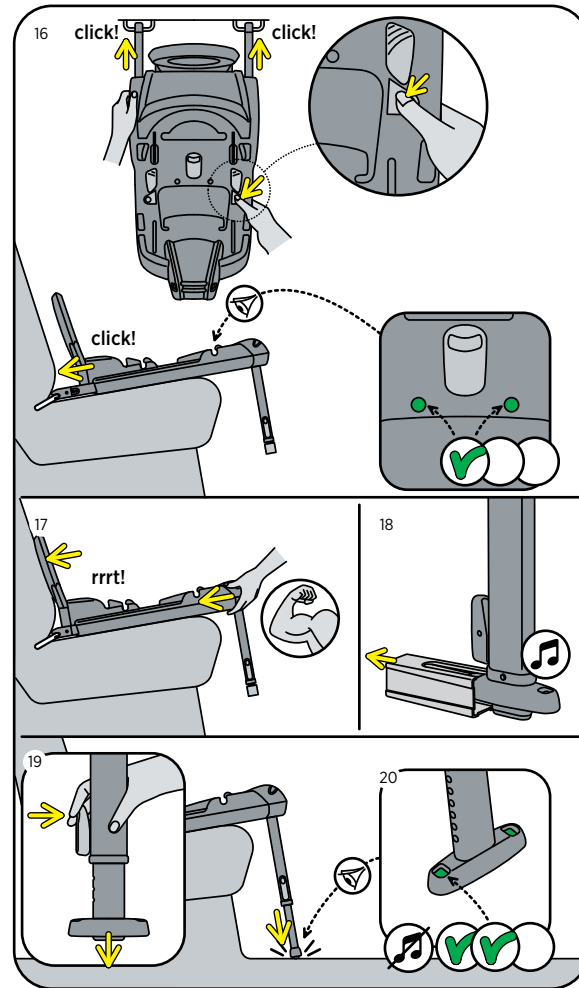
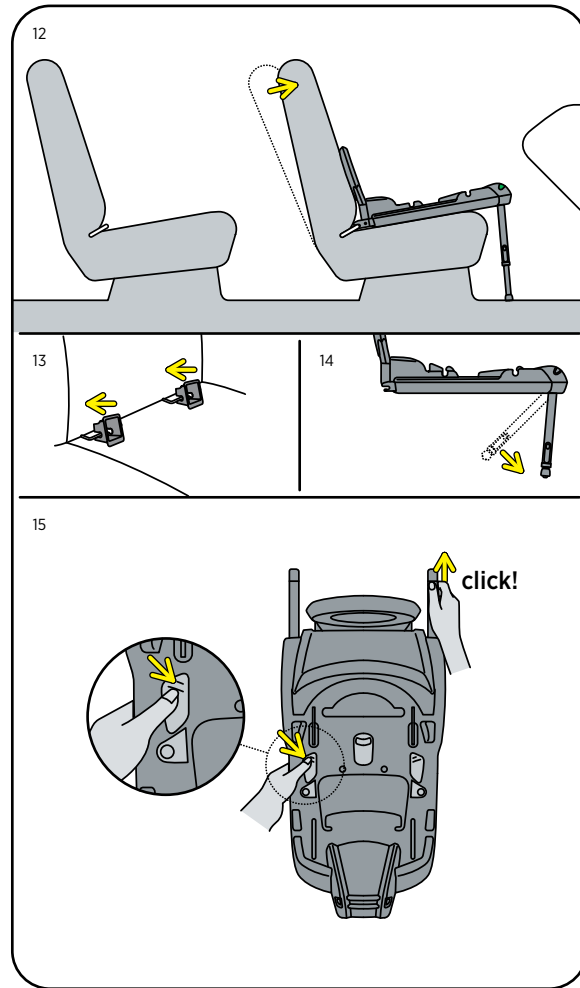
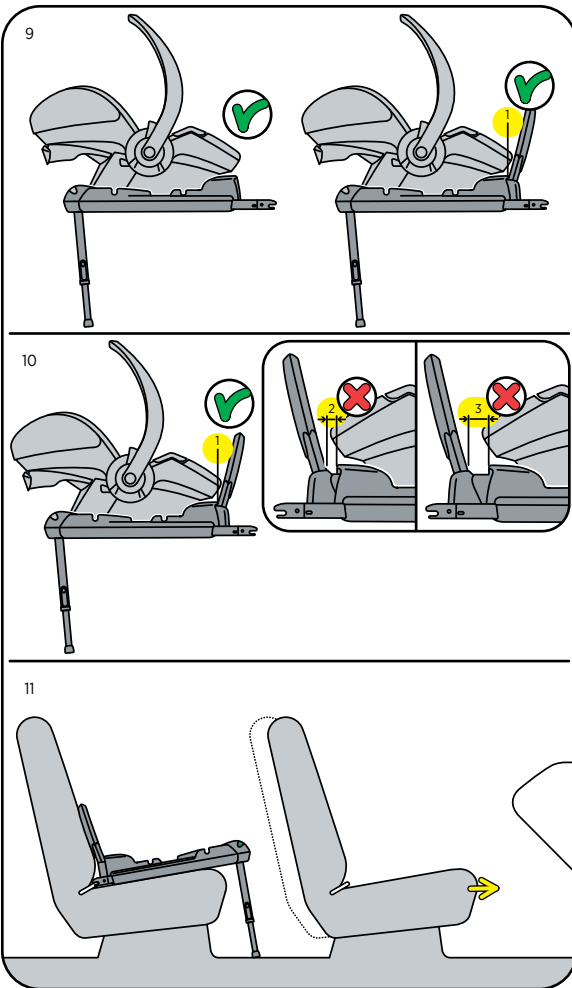

## Thank you for choosing BeSafe iZi Modular i-Size base

! It is important that you read this user manual BEFORE installing your seat. Incorrect installation could endanger your child.

### ! Vital information

- The child seat MUST NOT be installed in a front passenger seat WITH AN ACTIVATED AIRBAG.
- iZi Modular i-Size base can only be installed in a car equipped with ISOfix anchorage points.
- For the suitable positions in the car, read the vehicle handbook.
- Read the car list to find out whether your car model is approved for this seat.
- iZi Modular i-Size base can be used in combination with iZi Go Modular for stature height 40 - 75 cm, and iZi Modular for stature height 61 - 105 cm.
- The floor support must always be used. Make sure that the floor support is fully pushed down until it touches the floor of the vehicle in front of the seat and that the indicators on the floor support are always showing green.
- DO NOT attempt to dismantle, modify or add any part to the seat. Warranty will be void if non-original parts or accessories are used.
- Do not use any aggressive cleaning products; these may harm the construction material of the seat.
- BeSafe advises that child seats should not be bought or sold second-hand.
- KEEP this user manual for later use with the seat.
- DO NOT use the seat for longer than 7 years. Due to ageing, the quality of the material may change.
- If in doubt, consult either the car seat manufacturer or the retailer.



## Preparing to install

- Front brace (1a)
- Front brace box (1b)
- Floor support (1c)
- Floor support height indicator (1d)
- Height adjuster floor support (1e)
- Seat release handle (1f)
- ISOfix release switch (2g)
- ISOfix indicators (2x) (2h)
- Switch for ISOfix connectors (2x) (2i)
- ISOfix car anchorage (2x) (3j)
- ISOfix insertion clips (2x) (under side) (4k)
- ISOfix connectors (2x) (4l)

## Installation of the iZi Modular i-Size base

- The frontbrace is not delivered pre-installed in the base. The iZi Go Modular can be used on a base without the front brace.

! Warning: When used in combination with the iZi Modular, the front brace must be installed on the base. Install the front brace in the two openings, after pulling out the front brace box. The frontbrace is delivered only with iZi Modular (and available as accessory in case you want to use a second base for iZi Modular). (5,6,7)

1. When you want to enlarge the available leg room for the child in the car, you can pull out the front brace box before installation. Use this possibility only when the iZi Modular seat is in rearfacing position and when the seat is supported by a vehicle seat or dashboard in front of the car seat. (8)
2. The frontbrace has to remain on the base once it is installed. The iZi Go Modular can also be used on a base with the front brace installed. (9) When used in combination with iZi Go, the frontbrace has to be in position 1. (10)
3. Only disconnect the front brace when you want to transport the base flat. To disconnect the front brace, you have to pull the front brace upwards, while you push with a tool in the hole at the side of the front brace box. This should be done first on one side and then the other side.
4. When installing in the back seat of the vehicle, push the front seat of the vehicle forward as far as possible. (11)

5. When installing in the front seat of the vehicle, adjust the back rest into an upright position. (12)
6. If your vehicle is not equipped with ISOfix insertion clips, insert these to make installation easier. (13)
7. ISOfix insertion clips are underneath the base.
8. When the base is lifted the floor support should fall downwards from underneath the base. Do this outside the car. (14)
9. Push down one of the grey ISOfix releases on top of the base. The ISOfix connectors will appear at the back of the base. Pull the ISOfix connectors fully out. (15)
10. Position the base on the vehicle seat. Click the ISOfix connectors on to the ISOfix points on the vehicle seat. Make sure that both ISOfix indicators are green. (16)
11. During installation, you can prevent the ISOfix connectors from sliding in, by pushing at least on one side on the marked area in front of the grey isofix release switch. (16)
12. Push the base against the backrest of the vehicle seat until it is firmly in place. (17)
13. Remove the yellow cap from the floor support. The alarm sound will stop when the seat is installed correctly with the floor support in contact with the floor of the vehicle. (18)
14. Adjust the floor support, so it is in contact with the floor of the vehicle. (19)
15. The height indicator of the floor support shows green when the floor support is in contact with the floor. (20)
16. The alarm sound stops when the floor support indicators show green and it is in contact with the floor. (20)

## Removal of the base from the vehicle

1. To remove the base from the vehicle, you have to slide the central grey ISOfix release switch towards the front. Both isofix connectors will release from the vehicle
2. If removal is difficult, it can help to push the base towards the backrest of the vehicle, while pulling the ISOfix release switch.

## ! Warning: potential misuse

- The child seat MUST NOT be installed in a front passenger seat WITH AN ACTIVATED AIRBAG.
- The floor support must always be used. Make sure that the floor support is fully pushed down.
- When used in combination with iZi Modular the front brace must be fitted on the base.
- Make sure the indicators are green before you drive.



## Guarantee

- Should this product prove faulty within 24 months of purchase due to materials or manufacturing fault, except covers and harness straps, please return it to the original place of purchase.
- The guarantee is only valid when you use your seat appropriately and with care. Please contact your retailer, they will decide if the seat will be returned to the manufacturer for repair. Replacement or return cannot be claimed. The guarantee is not extended through repair.
- The guarantee expires: when there is no receipt, when defects are caused by incorrect and improper use, when defects are caused by abuse, misuse or negligence.

# BeSafe®

SCANDINAVIAN  
SAFETY

**UN regulation no. R129 i-Size**

Notice: This is an "i-Size" Child Restraint System. It is approved to Regulation No. 129, for use in, "i-Size compatible" vehicle seating positions as indicated by vehicle manufacturers in the vehicle users' manual. If in doubt, consult either the child restraint manufacturer or the retailer.

HTS BeSafe as  
N-3535 Krøderen, Norway - [www.besafe.com](http://www.besafe.com)